

## GENERAL PROVISIONS FOR MECHANICAL AND ELECTRICAL WORK

1. GUARANTEE: PROVIDE WRITTEN ONE YEAR GUARANTEE FOR ALL SYSTEMS AND EQUIPMENT. PROVIDE MANUFACTURER'S WARRANTIES THAT MAY APPLY TO SPECIFIC EQUIPMENT. ALL EQUIPMENT SHALL BE NEW AND UNUSED AND INSTALLED IN STRICT ACCORDANCE WITH MANUFACTURER'S INSTRUCTIONS AND RECOMMENDATIONS.

2. CODES AND STANDARDS: COMPLY WITH NATIONAL, MARYLAND AND TOWN OF EASTON CODES. MATERIALS, EQUIPMENT, AND SYSTEMS SHALL MEET ALL REQUIREMENTS FOR FIRE PROTECTION AND LIFE SAFETY. COMPLY WITH INTERNATIONAL CODE COUNCIL 2018 CODES (IBC, IMC, IPC, IECC); NATIONAL FIRE PROTECTION ASSOCIATION (NFPA); NATIONAL ELECTRIC CODE (NFPA 70); OFFICE OF THE MARYLAND STATE FIRE MARSHAL; UNDERWRITERS LABORATORY (UL); FACTORY MUTUAL (FM); AMERICAN SOCIETY FOR TESTING MATERIALS (ASTM); AMERICAN NATIONAL STANDARDS INSTITUTE (ANSI); AND NATIONAL ELECTRICAL MANUFACTURER'S ASSOCIATION (NEMA). ANYTHING DRAWN OR SPECIFIED SHALL NOT BE CONSTRUED TO CONFLICT WITH APPLICABLE CODE, LAW, REGULATION, OR ORDINANCE. RESOLVE ANY AND ALL POTENTIAL CONFLICTS PRIOR TO INSTALLATION.

3. COORDINATION: COORDINATE ALL WORK WITH EXISTING CONDITIONS AND OTHER TRADES. OWNER AND ARCHITECT RESERVE THE RIGHT TO RELOCATE SERVICES AND EQUIPMENT PRIOR TO ROUGH-IN AT NO COST TO OWNER. DRAWINGS, THOUGH TO SCALE, ARE DIAGRAMMATIC, CONVEYING INTENT OF EQUIPMENT AND SYSTEM INSTALLATION AND OPERATION. DO NOT SCALE DRAWINGS. MINOR REPOSITIONING OF EQUIPMENT SHALL BE MADE TO ALLOW FOR ACCESS, SERVICING, AND COORDINATION. EXPOSED CONSTRUCTION SHALL FOLLOW THE LINES OF THE BUILDING AND SHALL BE EVENLY SPACED.

4. SHOP DRAWINGS: SUBMIT SHOP DRAWINGS OF ALL EQUIPMENT AND MATERIALS TO BE FURNISHED.

5. RECORD DRAWINGS AND DATA: FURNISH TWO SET OF CLEAN DRAWINGS AT COMPLETION OF WORK. MODIFY AS REQUIRED TO SERVE AS "AS-BUILT" DRAWINGS. DRAWINGS SHALL BE MARKED "RECORD DRAWINGS SHOWING SIGNIFICANT CHANGES" AND BE SIGNED AND DATED BY THE CONTRACTOR.

FURNISH TWO SETS OF SHOP DRAWINGS AND MAINTENANCE MANUALS IN BROCHURE FORM FOR OWNER'S FILE, AT COMPLETION OF THE WORK. PROVIDE OWNER WITH SEARCHABLE .PDF FILE OF RECORD DRAWINGS, SHOP DRAWINGS, AND OWNER'S MANUALS.

6. PERMITS, FEES: SECURE AND PAY FOR ALL FEES AND CHARGES FOR THE WORK, MAKE ARRANGEMENTS FOR ALL REQUIRED INSPECTIONS AND FURNISH CERTIFICATE OF ACCEPTANCE AT COMPLETION OF JOB FROM LOCAL AUTHORITY.

7. SUBSTITUTIONS: NO SUBSTITUTIONS SHALL BE MADE WITHOUT PRIOR APPROVAL FROM THE OWNER OR ARCHITECT.

8. GENERALLY ALL EXISTING EQUIPMENT, PIPING, DUCTWORK, RECEPTACLES AND BRANCH CIRCUITS SHALL REMAIN, EXCEPT WHERE SPECIFICALLY INDICATED TO BE REMOVED. USE CARE TO PRESERVE EXISTING EQUIPMENT THAT IS TO BE REMOVED, RELOCATED, AND REINSTALLED. PROVIDE WIRING AS REQUIRED TO PRESERVE CONNECTIVITY OF EXISTING BRANCH CIRCUITS. PERFORM ALL REQUIRED DEMOLITION IN AREAS OF WORK AS SHOWN ON ARCHITECTURAL AND MECHANICAL AND ELECTRICAL PLANS. DEMOLISHED EQUIPMENT SHALL BE COMPLETELY REMOVED, INCLUDING INSULATION, WIRING, CONDUIT, BOXES, AND SUPPORT. DEMOLITION OF DEVICES AND EQUIPMENT SHALL BE COMPLETE WITH REMOVAL OF WIRES, CABLES, AND CONDUIT BACK TO ACTIVE CIRCUITRY.

9. CUTTING AND PATCHING: SEQUENCE AND COORDINATE INSTALLATION FOR EFFICIENT FLOW OF THE WORK. GIVE PARTICULAR ATTENTION TO LARGE EQUIPMENT PRIOR TO CLOSING-IN THE BUILDING. ARRANGE FOR CHASES AND OPENINGS IN BUILDING COMPONENTS TO ALLOW INSTALLATION OF MECHANICAL AND ELECTRICAL EQUIPMENT. COORDINATE THE INSTALLATION OF SLEEVES AND SUPPORTS WITH STRUCTURAL COMPONENTS. CUTTING SHALL BE BY GENERAL CONTRACTOR, BUT PAID FOR BY CONTRACTOR REQUIRING THE WORK. PATCHING AND FURRING SHALL BE BY GENERAL CONTRACTOR. PATCHING REQUIRED AFTER COMPLETION OF WORK SHALL BE PAID FOR BY CONTRACTOR CAUSING THE WORK.

10. CLEANING UP: BROOM CLEAN WORK AREAS AT CLOSE OF EACH DAY. CLEAN AND TOUCH-UP PAINT ALL EQUIPMENT AT COMPLETION OF WORK. PROTECT ALL EQUIPMENT FROM DAMAGE DURING CONSTRUCTION. PROVIDE NAME PLATES ON ALL EQUIPMENT.

11. TESTS: PLUMBING CONTRACTOR SHALL TEST ALL PIPING SYSTEMS PER EASTON UTILITIES REQUIREMENTS AND INCLUDE COST OF TESTING IN THE BID; REPAIR ALL LEAKS. STERILIZE ALL NEW WATER PIPING PER TALBOT COUNTY AND STATE OF MARYLAND HEALTH DEPARTMENT PROCEDURES. TEST ALL EQUIPMENT AND PROVE PERFORMANCE. REPLACE ANY AND ALL DEFECTIVE DEVICES OR SYSTEMS. TEST MECHANICAL UNITS IN BOTH HEATING AND COOLING MODES. INSTRUCT OWNER IN OPERATION OF ALL SYSTEMS. PROVIDE TESTS FOR CONTINUITY, GROUND, POLARIZATION, AND INSULATION OF WIRING AND EQUIPMENT. AFTER OBTAINING SUCCESSFUL TESTS CONTRACTOR SHALL CALL FOR INSPECTIONS AND APPROVALS PRIOR TO ANY WORK BEING CONCEALED.

A. PLUMBING ROUGH-IN TESTING: DRAIN, WASTE, AND VENT SYSTEM SHALL BE TESTED BY CLOSING OFF ALL OPENINGS EXCEPT VENT TERMINATIONS AT ROOF LINE, FILL ALL HORIZONTAL AND VERTICAL PIPING WITH WATER & CHECK FOR LEAKS. ANY LEAKS SHALL BE REPAIRED AND TEST REPEATED. POTABLE WATER LINES SHALL BE TESTED WITH A SINGLE CHARGE OF AIR AT 100 PSI, PRESSURE SHALL HOLD FOR A PERIOD OF THIRTY MINUTES WITHOUT ANY LOSS. ANY LEAKS SHALL BE REPAIRED AND TEST REPEATED.

B. FINAL TEST OF WATER SUPPLY SYSTEM AFTER FIXTURES ARE SET, WATER PIPING SHALL BE TESTED WITH A SINGLE CHARGE OF AIR AT 50 PSI, PRESSURE SHALL HOLD FOR A PERIOD OF THIRTY MINUTES WITHOUT ANY LOSS. ANY LEAKS SHALL BE REPAIRED AND TEST REPEATED. AFTER OBTAINING SUCCESSFUL TEST, CONTRACTOR SHALL CALL FOR FINAL INSPECTION AND APPROVAL.

12. NOISE AND VIBRATION: ALL EQUIPMENT SHALL OPERATE WITH A MINIMUM OF NOISE AND VIBRATION. PROVIDE VIBRATION ISOLATORS, FLEXIBLE CONNECTIONS, AND INSULATION FOR NOISE CONTROL. CONTRACTOR SHALL RECTIFY OBJECTIONABLE CONDITIONS.

13. EQUIPMENT: PROVIDE ALL MATERIAL AND LABOR TO CONNECT EQUIPMENT FURNISHED IN OTHER SECTIONS OR BY OWNER. FIELD CHECK EQUIPMENT DIMENSIONS AND ROUGHING-IN, AND FURNISH ALL OUTLET BOXES, DISCONNECTS, VALVES, TRAPS, ETC. AS REQUIRED TO INSTALL THE EQUIPMENT.

14. VISITING THE JOB SITE: CONTRACTOR SHALL VISIT THE SITE OF THE PROPOSED CONSTRUCTION IN ORDER TO FULLY UNDERSTAND THE FACILITIES, DIFFICULTIES AND RESTRICTIONS ATTENDING THE EXECUTION OF THE WORK. NO ADDITIONAL COMPENSATION WILL BE ALLOWED THIS CONTRACTOR FOR WORK OR ITEMS OMITTED FROM HIS ORIGINAL PROPOSAL DUE TO THIS FAILURE TO INFORM HIMSELF REGARDING SUCH MATTERS AFFECTING THE PERFORMANCE OF THE WORK. ANY DISCREPANCIES DETERMINED OR OMISSIONS FOUND IN THE DRAWINGS OR IRREGULARITIES IN THE EXISTING CONDITIONS SHALL BE BROUGHT TO THE ARCHITECT AND OWNER'S ATTENTION PRIOR TO SUBMITTING BID.

## MECHANICAL

1. PROVIDE ALL LABOR AND MATERIALS FOR A COMPLETE MECHANICAL SYSTEM. PROVIDE FURNACE, SPLIT SYSTEM HEAT PUMP, AND FANS AS SCHEDULED AND DETAILED ON DRAWINGS. PROVIDE PERMANENT IDENTIFICATION LABELS FOR ALL EQUIPMENT.

2. DUCTWORK: ALL SUPPLY, RETURN, AND EXHAUST DUCTS, SUPPORTS, OR ALL OTHER DUCT MATERIALS SHALL BE G60 GALVANIZED STEEL, UNLESS NOTED OTHERWISE. DUCTS SHALL BE RECTANGULAR OR ROUND CONSTRUCTED TO SMACNA CLASS A LEAKAGE CLASS TO 2". DUCT JOINTS AND SEAMS SHALL BE SEALED AIRTIGHT WITH FIRE RATED DUCT SEALANT. DUCT DIMENSIONS SHOWN ARE CLEAR INSIDE DIMENSIONS. DUCT FLEXIBLE CONNECTIONS SHALL BE PROVIDED IN AND OUT OF EACH FAN UNIT, VENTGLAS FABRIC, 3" LONG. SUPPORT DUCTS 6" ON CENTERS WITH 1" BY 16 GAUGE HANGERS, WITH SHEETMETAL SCREWS ON BOTTOM, AND 12" ON CENTER ON SIDES. GAUGES, FABRICATION, AND INSTALLATION SHALL CONFORM TO LATEST SMACNA LOW PRESSURE DUCT MANUAL. ALL ABRUPT ELBOWS HAVE DOUBLE THICKNESS TURNING VANES OR BE LONG RADIUS.

3. ELECTRICAL: COORDINATE ELECTRICAL CHARACTERISTICS OF MECHANICAL EQUIPMENT WITH ELECTRICAL CONTRACTOR. ALL LOW VOLTAGE CONTROL WIRING SHALL BE BY MECHANICAL CONTRACTOR.

4. GRILLES, REGISTERS, AND DIFFUSERS: AS SPECIFIED ON THE DRAWINGS. WALL AND CEILING OUTLETS SHALL HAVE FINISHES TO MATCH SURFACE FINISH AS SCHEDULED, WITH BLACK INTERIOR. HART & COOLEY, TUTTLE & BAILEY, METALAIRE, PRICE, OR TITUS.

## ELECTRICAL:

1. GENERAL: PROVIDE ALL MATERIALS AND LABOR FOR A COMPLETE ELECTRICAL SYSTEM AS INDICATED BY THE PROJECT DOCUMENTS AND IN COMPLIANCE WITH MINIMUM CODE REQUIREMENTS. THE ELECTRICAL DRAWINGS DIAGRAMMATICALLY INDICATE LOCATIONS AND EQUIPMENT AND CIRCUITS, FEEDERS, AND HOME RUNS, BUT DO NOT SPECIFICALLY INDICATE ACTUAL ROUTING. ELECTRICAL CONTRACTOR SHALL DETERMINE EXACT LAYOUT OF EQUIPMENT AND WIRING AND SHALL COORDINATE WITH OTHER TRADES, BUILDING ARCHITECTURE AND STRUCTURE.

2. ELECTRICAL SERVICE: EXISTING ELECTRIC SERVICE TO REMAIN. COORDINATE THE ELECTRICAL SYSTEMS WITH THE UTILITY SERVICE AND PROVIDE THE REQUIRED CONNECTIONS TO THE SERVICE. COMPLY WITH UTILITY REQUIREMENTS AND REGULATIONS.

3. TELEPHONE AND CABLE SERVICES ARE EXISTING TO REMAIN.

4. OUTLET AND JUNCTION BOXES: A BOX SHALL BE PROVIDED AT EACH AND EVERY OUTLET LOCATION INDICATED ON THE DRAWINGS AND AS REQUIRED AT JUNCTIONS AND PULL POINTS. SWITCH, TELEPHONE, DATA, AND RECEPTACLE BOXES SHALL BE USED WHERE MORE THAN ONE DEVICE IS TO BE INSTALLED IN A SINGLE LOCATION.

5. PULL BOXES: PULL BOXES SHALL BE PROVIDED IN LONG RUNS, OR WHERE EXCESS TURNS ARE ENCOUNTERED, AND ELSEWHERE AS REQUIRED BY CODE. ALL CONDUIT USED FOR LIGHTING AND POWER SHALL NOT HAVE MORE THAN FOUR (4) BENDS IN ANY ONE RUN WITHOUT PULL BOXES.

6. CONDUCTORS: ALL BUILDING BRANCH CIRCUIT WIRING SHALL BE COPPER, TYPE THHN OR THWN RATED 600 VOLTS AND 90C INSULATION. #2 AWG AND LARGER WIRING MAY BE STRANDED, COMPACTED ALUMINUM ALLOY 8030 WITH XHHW-2 INSULATION. WIRE SIZES SHALL BE BASED ON 75C INSULATION. NO WIRE SMALLER THAN NO. 12 SHALL BE USED FOR LIGHTING, CONVENIENT OUTLETS OR POWER OUTLETS.

7. SPLICES AND TAPS: SPLICES AND TAPS SHALL BE MADE ONLY IN APPROVED BOXES WITH APPROVED POLARIS TYPE CONNECTORS INSTALLED PER MANUFACTURER'S INSTRUCTIONS.

8. CONDUIT AND TUBING: ALL WIRING FOR ALL LINE VOLTAGES SHALL BE INSTALLED IN CONDUIT OR TUBING. CONDUIT SIZES SHALL BE BASED ON 75C CONDUCTOR INSULATION, MINIMUM SIZE SHALL BE 3/4 INCH. RIGID GALVANIZED STEEL CONDUIT SHALL BE USED OUTSIDE THE BUILDING, EXPOSED PANEL FEEDERS, AND AT ANY LOCATION SUBJECT TO MECHANICAL INJURY. CONDUIT BELOW GRADE OR SLAB SHALL BE PVC. ELECTRICAL METALLIC TUBING (EMT) MAY BE USED FOR ALL INTERIOR WORK ABOVE FLOOR LINES, EXCEPT WHERE RIGID GALVANIZED STEEL CONDUIT IS REQUIRED. FITTINGS SHALL BE OF THE COMPRESSION THREADLESS TYPE. INDENTATION, SET-SCREW OR TAP-ON TYPES WILL NOT BE PERMITTED.

9. FLEXIBLE CONDUIT: METAL CLAD (MC) CABLE SHALL BE GALVANIZED STEEL OR ALUMINUM AND SHALL BE USED ONLY AS PERMITTED BY CODE. MC CABLE MAY BE USED FOR MOTOR CONNECTIONS, CONNECTION OF EQUIPMENT, BRANCH CIRCUIT WIRING, AND WHERE APPROVED FOR BRANCH PANEL FEEDERS, CONCEALED IN WALLS OR ABOVE CEILINGS. SEALTITE CONDUIT WITH WATER PROOF TYPE FITTINGS SHALL BE USED WHEN EXPOSED TO WEATHER OR IN DAMP LOCATIONS.

10. SUPPORTS: CONDUITS THAT ARE CONCEALED MAY BE RUN ON PIPE SUPPORTS OR FASTENED AT EACH JOINT WITH GALVANIZED CONDUIT HANGERS. SUPPORTS SPACING SHALL BE PER CODE.

11. IDENTIFYING NAMEPLATE: EACH PANEL, SAFETY SWITCH, STARTER OR OTHER MAJOR ELECTRICAL ITEM OF EQUIPMENT SHALL BE IDENTIFIED WITH A PLASTIC ENGRAVED NAMEPLATE.

12. PANELS-GENERAL: THE MAKEUP OF THE PANEL SHALL BE AS INDICATED ON THE DRAWING. PROVIDE PANEL WITH TYPED-IN CIRCUIT DIRECTORIES. CIRCUIT BREAKERS SHALL BE COMPATIBLE WITH EXISTING PANELS AND BE THERMAL MAGNETIC OR ELECTRONIC TRIP. MULTI-POLE BREAKER SHALL BE ONE PIECE, COMMON TRIP WITH SINGLE HANDLE. PROVIDE FEATURES SUCH AS SHUNT TRIP, ARC-FAULT CIRCUIT INTERRUPTION, AND GROUND FAULT CIRCUIT INTERRUPTION. PANEL EQUIPMENT SHALL BE RATED AT 75C MINIMUM. VERIFY REQUIRED CIRCUIT BREAKER INTERRUPTING CAPACITY WITH EASTON UTILITIES. UNLESS OTHERWISE INDICATED, AS BASIS FOR PRICING, ASSUME 65 KAIC FOR SERVICE ENTRANCE EQUIPMENT. BALANCE POWER LOADS EQUALLY (WITHIN 10 PERCENT) ON ALL PHASES. PANELS SHALL BE AS SCHEDULED.

13. SAFETY SWITCHES AND STARTERS: SAFETY SWITCHES AND STARTERS SHALL BE FURNISHED WITH NEMA RATINGS, NUMBER OF POLES, ETC. AS INDICATED, FUSED OR UNFUSED AS NOTED. FUSED DISCONNECTS ON SERVICE SHALL LIMIT THE FAULT CURRENT TO THE COMPUTED AMPERAGE. NEMA 3R WEATHERTIGHT ENCLOSURES SHALL BE PROVIDED FOR SWITCHES LOCATED OUTSIDE.

14. LIGHTING FIXTURES: LIGHTING FIXTURES SHALL BE AS INDICATED ON THE DRAWINGS, OR APPROVED EQUAL. ALL FIXTURES SHALL BE PROVIDED COMPLETE WITH LAMPS AND ACCESSORIES FOR MOUNTING.

15. WIRING DEVICES: WIRING DEVICES SHALL BE SPECIFICATION GRADE, 20 AMP, GROUNDING TYPE, COLOR AND FINISH SHALL BE AS DETERMINED BY OWNER OR ARCHITECT, OF THE TYPE AND CAPACITY REQUIRED. MANUFACTURER SHALL BE HUBBELL, BRYANT, GENERAL ELECTRIC, PASS AND SEYMOUR OR EQUAL AS SCHEDULED HUBBELL PART NUMBER:  
RECEPTACLE: BR20-  
USB RECEPTACLE: USB20X2-  
TAMPER RESISTANT RECEPTACLE: BR20-TR  
WEATHER RESISTANT AND TAMPER RESISTANT: BR20-WRTR  
GROUND FAULT CIRCUIT INTERRUPT: GF20-

16. DEVICE PLATES: DEVICE PLATES SHALL BE OF THE SAME MANUFACTURER AS THE DEVICE AND SHALL BE OF UNBREAKABLE NYLON OF SAME COLOR AS DEVICE. COLOR SELECTED BY ARCHITECT.

17. GROUNDING: THE GROUNDED NEUTRAL OF THE SECONDARY DISTRIBUTION SYSTEM SHALL BE SUPPLEMENTED BY AN EQUIPMENT GROUNDING SYSTEM TO PROPERLY SAFEGUARD THE EQUIPMENT AND PERSONNEL. THE GROUNDING SYSTEM SHALL COMPLY WITH ALL REQUIREMENT OF NATIONAL ELECTRICAL CODE.

18. TESTING: AFTER THE INSTALLATION OF THE ELECTRICAL SYSTEM HAS BEEN COMPLETED, THE CONTRACTOR SHALL CONDUCT OPERATING TESTS FOR APPROVAL. ALL EQUIPMENT SHALL BE DEMONSTRATED TO OPERATE IN ACCORDANCE WITH THE REQUIREMENTS OF THESE SPECIFICATIONS. TEST REPORTS SHALL BE PROVIDED FOR THE FOLLOWING AND SHALL BE INCLUDED IN THE OWNER'S PROJECT MANUAL:

A. WIRE AND CABLE TESTS - ANSI/NETA MTS2007 1000VDC MEGGER FOR ONE MINUTE WITH MINIMUM RESISTANCE 100 MEGOHMS.  
B. GROUNDING SYSTEM TESTS. MAXIMUM RESISTANCE TO GROUND SHALL BE 13 OHMS.  
C. VOLTAGE AND CURRENT READINGS FOR EACH FEEDER AND MOTOR CIRCUIT.  
D. OPERATION OF LIGHTING AND RECEPTACLE CIRCUITS WITH ASSOCIATED SWITCHING AND CONTROLS.  
E. CIRCUITS SHALL BE TESTED FOR CORRECT POLARITY AND GROUNDING.

## PLUMBING:

1. PROVIDE ALL MATERIALS AND LABOR FOR A COMPLETE PLUMBING SYSTEM. EXTEND ALL SERVICES TO THE EXISTING SERVICES IN THE BUILDING AND AT THE SITE AND MAKE FINAL CONNECTIONS.

2. VALVES IN WATER LINES 2" AND SMALLER SHALL BE TWO PIECE, 600 WOG, BRASS, QUARTER TURN BALL VALVES, NO EXCEPTIONS - APOLLO, CONBRACO, MILWAUKEE, NIBCO, WATTS.

3. PIPE HANGERS: SECURELY SUPPORT PIPES FROM BUILDING CONSTRUCTION. INDIVIDUAL HANGERS SHALL BE CLEVIS STYLE. MULTIPLE PIPES SHALL BE SUPPORTED ON UNISTRUT P-1000. WALL SUPPORTS SHALL BE GRINNELL #L68. SUPPORT ON CENTERS WITH DIAMETER ROOS PER CODE AND AT CHANGE OF DIRECTION. ALL MATERIALS USED IN SUPPORTING PIPE TO BE GALVANIZED. PROVIDE CRANE CHROMIUM PLATED WALL, CEILING AND FLOOR PLATES WHERE PIPES PASS THROUGH WALLS OR CEILINGS. PROVIDE GALVANIZED STEEL SLEEVES FOR PIPES THROUGH WALLS.

4. INSULATION: INSULATE DOMESTIC HOT WATER PIPING WITH ARMAFLEX PIPE INSULATION PER 2018 IPC AND IECC. INSULATION AT FITTINGS SHALL BE CUT AND MOLDED TO FIT. INSULATE DOMESTIC COLD WATER PIPING WITH SAME INSULATION, 1/2" TO PREVENT CONDENSATION.

5. PIPING AND FIXTURE INSTALLATIONS SHALL CONFORM WITH ADA ACCESSIBILITY GUIDELINES, ANSI A117.1, INCLUDE OFFSET DRAINS AND INSULATED SUPPLIES AND TRAPS FOR ALL LAVATORIES.

6. DRAIN SYSTEMS: SANITARY PIPING, WASTE LINES, AND VENT PIPING SHALL BE SCHEDULE 40 PVC DWV, CONFORMING TO ASTM D2665. FOAM CORE PVC PIPING SHALL NOT BE USED.

7. WATER SYSTEM: DOMESTIC WATER PIPING INDOORS, ABOVE GRADE OR SLAB SHALL BE TYPE "L" HARD DRAWN COPPER TUBING WITH WROUGHT COPPER FITTINGS AND LEAD FREE SOLDER OR SCHEDULE 40 CPVC FOR SIZES 2" AND SMALLER. PROVIDE ADAPTORS AT TRANSITIONS IN PIPING MATERIALS AND DIELECTRIC FITTINGS AT POINTS OF CONNECTION OF DISSIMILAR METALS. ALL WATER PIPING SHALL BE PRESSURE RATED WITH MINIMUM WORKING PRESSURE OF 160 PSIG AT 73F, AND CONFORM TO NSF 61.

8. GAS PIPING ABOVE GRADE SHALL BE SCHEDULE 40 BLACK STEEL WITH THREADED JOINTS AND FITTINGS. PIPING EXPOSED TO WEATHER SHALL BE PAINTED YELLOW.

9. PIPE INSTALLATION: INSTALL WATER PIPING LEVEL. PROVIDE DRAINS AT LOW POINTS OF SYSTEM. SEWERS SHALL BE SLOPED AT NOT LESS THAN 1/8 INCH PER FOOT. PIPE SHALL RUN PARALLEL TO THE BUILDING LINES. FULL PROVISION SHALL BE MADE FOR EXPANSION AND CONTRACTION OF PIPING. VENT PIPES SHALL EXTEND 12" ABOVE ROOF AND BE FLASHED AT THE ROOF. HOSE CONNECTIONS SHALL HAVE VACUUM BREAKERS. PROVIDE A STOP VALVE AT EACH AND EVERY FIXTURE OR EQUIPMENT. ALL CONNECTIONS TO EQUIPMENT SHALL BE MADE WITH UNIONS. PIPING SHALL NOT CONTACT ELECTRICAL CONDUIT AT ANY POINT. ACCESS DOORS OR PANELS SHALL BE FURNISHED BY THIS CONTRACTOR TO SERVICE ALL CONCEALED VALVES AND EQUIPMENT. PIPING BELOW SLAB SHALL BE TRENCHED AS REQUIRED TO PROVIDE PROPER SLOPES. BACKFILL TRENCHES TO ORIGINAL COMPACTION.

10. JOINTS:  
A. COPPER PIPE - 95% TIN, 5% ANTIMONY SOLDER JOINTS OR BRAZED. ALL SOLDER SHALL BE LEAD FREE.  
B. PVC AND CPVC PIPE - PRIMER AND SOLVENT WELDED, AS RECOMMENDED BY THE MANUFACTURER.  
C. GAS PIPING JOINTS SHALL BE 250# IRON, THREADED.

11. PLUMBING FIXTURES AND ACCESSORIES SHALL BE AS SCHEDULED ON THE PLANS. IN GENERAL THE PRODUCTS SHALL BE AMERICAN STANDARD, KOHLER, CRANE, TOTO, FIAT, HAWS, AND ELKAY. TOILET SEATS SHALL BE CHURCH OR OLSONITE. CLEANOUTS SHALL BE JOSAM, J.R. SMITH, MIFAB, OR ZURN.

12. MISCELLANEOUS:  
A. EXPOSED TRAPS AND DRAINS FOR LAVATORIES AND SINKS: SHALL BE CHROME PLATED 1-1/4" OR 1-1/2" CAST BRASS "P" TRAP WITH 17 GAUGE TUBING TO WALL AND CHROME PLATED ESCUTCHEON. PROVIDE CLEANOUTS IN BOTTOM OF TRAPS.  
B. STOPS AND SUPPLIES: WHERE NOT SPECIFIED ELSEWHERE SUPPLIES AND STOPS SHALL BE 3/8" BRASS, QUARTER TURN, BALL VALVES, CHROME PLATED, WITH CHROME PLATED ESCUTCHEON AT WALL. PIPE TUBE EXTENDING FROM WALL TO STOP AND FROM STOP TO FIXTURE CONNECTIONS SHALL BE CPVC.

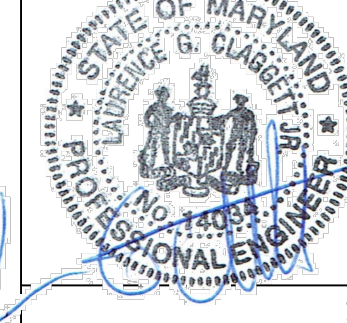
	<b>CLAGGETT ENGINEERING</b>		122 NORTH HARRISON STREET EASTON, MARYLAND 21601 TEL (410) 820-9173
	Professional Certification. I hereby certify that these documents were prepared or approved by me, and that I am a duly licensed professional engineer under the laws of the State of Maryland, License Number 14034, Expiration Date 7-24-24.		
<b>St. Vincent de Paul Addition</b> <b>Talbot County, MD</b>			
SCALE	AS NOTED	REVISIONS	BY DATE
DATE	4-24-24		
DRN	CE	CKD	LGC
APVD	LGC		
TITLE	<b>MEP SPECIFICATIONS</b>		NO. <b>ME100</b>



**SPECIAL NOTES** (APPLY TO THIS DRAWING ONLY)

- 1 COORDINATE COLOR AND FINAL LOCATION WITH ARCHITECT.
- 2 WALL CAP ON NEW GABLE END ABOVE EXISTING ROOF EQUAL TO GREENHECK WC-10x3. COORDINATE COLOR AND FINAL LOCATION WITH ARCHITECT.
- 3 REMOVE EXISTING FAN AND PRESERVE FOR REINSTALLATION. CLEAN FAN AND REINSTALL AT LOCATION INDICATED.
- 4 HVAC SYSTEMS IN THIS AREA ARE EXISTING TO REMAIN.
- 5 WHERE CEILINGS ARE BEING REPLACED, REMOVE EXISTING AIR DEVICES AND PRESERVE FOR REINSTALLATION. CLEAN AIR DEVICES AND REINSTALL IN NEW CEILINGS AT ORIGINAL LOCATIONS.
- 6 REMOVE EXISTING SOCK DUCT AND VOLUME DAMPERS AND PRESERVE FOR REINSTALLATION. CLEAN SOCK DUCT AND REINSTALL AT LOCATION INDICATED.
- 7 BALANCE TO 810 CFM.
- 8 EXISTING LOW RETURN GRILLE TO REMAIN.
- 9 EXISTING THERMOSTAT TO REMAIN.
- 10 INSTALL TRANSFER GRILLE CLOSE TO CEILING.
- 11 PROVIDE TWO PAIRS OF TRANSFER GRILLES WITH FIRE DAMPERS FOR AIR CIRCULATION. INSTALL ONE PAIR AT 8" AFF TO BOTTOM OF GRILLE AND THE SECOND PAIR AT 8'-0" AFF TO BOTTOM OF GRILLE.

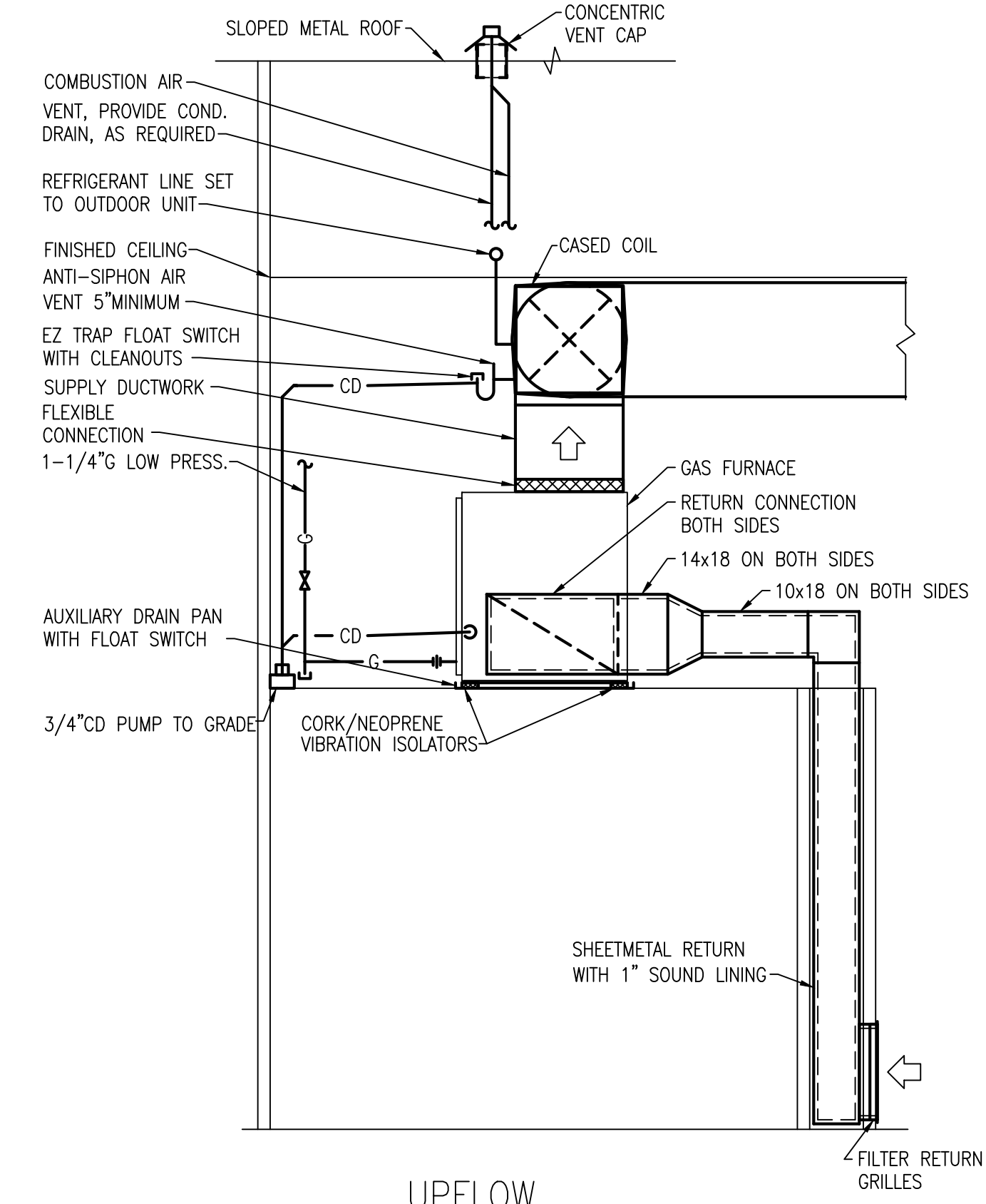
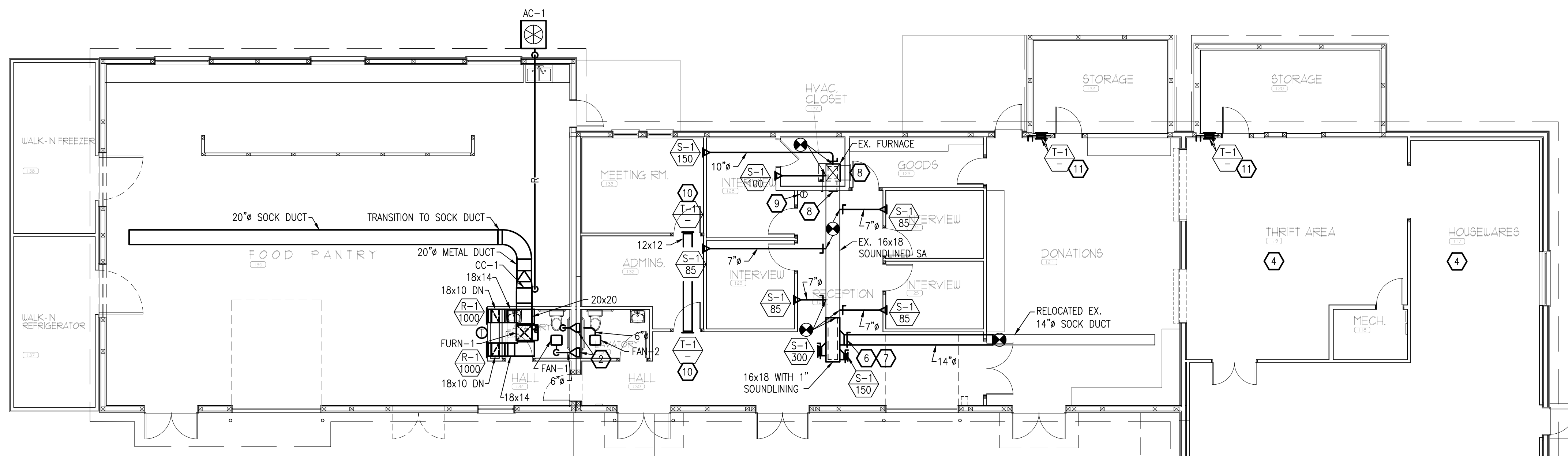

**MECHANICAL LEGEND**

SYMBOL	ABBREV.	DEFINITION
---	CW	COLD WATER
---	HW	HOT WATER
---	V	VENT
---	SAN	SANITARY, SOIL OR WASTE
---	INV	PIPE INVERT ELEVATION
---	G	NATURAL GAS
---	CD	CONDENSATE DRAIN
---	R	REFRIGERANT
---	SV	SHUTOFF VALVE
---	GR	GAS PRESSURE REGULATOR
---	CV	CHECK VALVE
---	PD	PIPE DOWN
---	PU	PIPE UP
---	UN	UNION
---	CP	CAPPED PIPE
---	WH	WALL HYDRANT
---	HB	HOSE BIBB
---	CO, GCO	CLEANOUT, GRADE CLEANOUT
---	FD	FLOOR DRAIN
---	SA	SUPPLY AIR DUCT (UP, DOWN)
---	RA	RETURN AIR DUCT (UP, DOWN)
---	EA	EXHAUST AIR DUCT (UP, DOWN)
---	SD	SUPPLY DIFFUSER W/ RUNOUT
---	RD	RETURN GRILLE W/ RUNOUT
---	ED	EXHAUST GRILLE W/ RUNOUT
---	VD	VOLUME DAMPER
---	CX	CONNECT TO EXISTING
---	RX	REMOVE EXISTING
---	SL	SOUND LINED DUCTWORK
---	(TYP)	TYPICAL
---	AFF	ABOVE FINISHED FLOOR
---	ASSOC.	ASSOCIATED
---	CFM	CUBIC FEET PER MINUTE
---	CONT.	CONTINUED
---	DWG.	DRAWING
---	GPM	GALLONS PER MINUTE
---	MBH	THOUSAND BTU PER HOUR
---	MH	MOUNTING HEIGHT
---	MIN	MINIMUM
---	KW	KILOWATT
---	IN	INCH(ES)
---	F	DEGREES FARENHEIT
---	QTY.	QUANTITY

**GAS FURNACE & SPLIT SYSTEM AIR CONDITIONER SCHEDULE & DETAILS**

SYSTEM DESIGNATION	FURN-1
CONFIGURATION	UPFLOW
FURNACE MODEL - YORK	TMBE120
INPUT MBH	120
AFUE	95
GAS RUNOUT (IN.)	3/4
COMBUSTION VENT (IN.)	3
REFRIGERANT	3
E.S.P. (IN. W.G.)	0.6
CFM	1925
MOTOR MCA @ 115V	14.5
INDOOR UNIT MOC	20
OPTIONS TO BE PROVIDED: A: MEDIA FILTER CABINET WITH ACCESS DOOR & STANDARD SIZE MERV 8 FILTERS.	
DESIGNATION	AC/CC-1
AIR CONDITIONER MODEL - YORK	YH2E60
CASED COIL MODEL - YORK	XAFD60
CFM (NOMINAL COOLING)	1900
TOTAL COOLING (NOMINAL TONS)	5
UNIT MCA	30.3
MAX. CIRCUIT BREAKER AMPS	50
VOLTS/PHASE	208/1
NOMINAL SEER	14.3

NOTES: 1. CAPACITIES RATED AT A.R.I. CONDITIONS.  
 2. THERMOSTATS SHALL BE 7-DAY PROGRAMMABLE WITH DEHUMIDIFICATION CONTROL, 1 STAGE COOL, 1 STAGE HEAT, EQUAL TO HONEYWELL MODEL VISIONPRO 8000.  
 3. UNITS SHALL BE COMPLETE WITH ALL ACCESSORIES REQUIRED OR RECOMMENDED, INCLUDING CRANKCASE HEATERS, MOTOR-MASTER CONTROLLER, BALL-BEARING FAN MOTOR, CAPACITOR RELAY COMPRESSOR START ASSIST, CYCLE PROTECTOR, THERMOSTATIC EXPANSION VALVE, OUTDOOR AIR TEMPERATURE SENSOR, ISOLATION RELAY, SUPPORT PAD AND FEET.

**BUILDING SECTION**  
SCALE: 1/8"=1'-0"

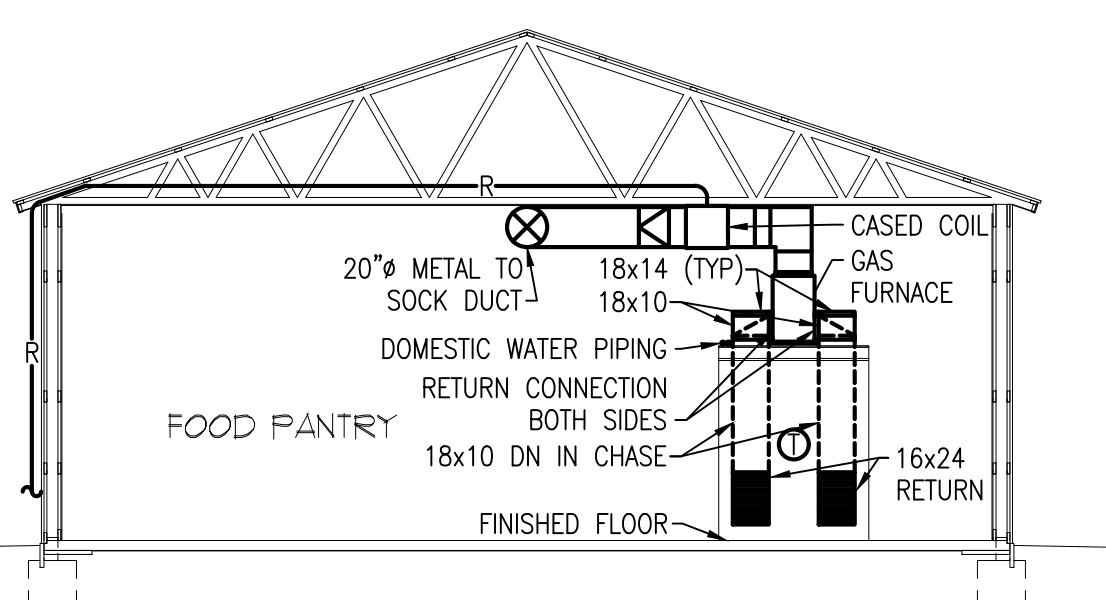

AIR DEVICE SCHEDULE					
MARK	TYPE	CFM	NECK	FLEX RUNOUT	PRICE MODEL #
S-1	SUPPLY GRILLE	0-210	8x6	-	32/C/S/A/B12 WITH INSULATED BOOT
		215-275	12x6	-	32/C/S/A/B12 WITH INSULATED BOOT
		280-420	12x8	-	32/C/S/A/B12 WITH INSULATED BOOT
R-1	RETURN HD GYM GRILLE	1000	24x16	-	90FH/S/A/B12
T-1	TRANSFER GRILLE	-	12x12	-	535/F/L/A/B12 WITH INSULATED BOOT

NOTES: 1. PROVIDE INSULATED BOOTS, PLENUMS, AND RECTANGULAR TO ROUND ADAPTORS FOR ALL AIR DEVICES. 2. PROVIDE POWDER COAT PAINT FOR ALL PAINTED AIR DEVICES. 3. FOR LOUVERED SIDEWALL GRILLES WITH A SQUARE NECK, INSTALL GRILLES WITH LOUVERED BLADES PARALLEL TO THE FLOOR.

**FAN SCHEDULE AND DETAIL**  
NO SCALE

DESIGNATION	FAN-1,2
AREA SERVED	RESTROOM
FAN TYPE	CEILING
MANUFACTURER	GREENHECK
MODEL	SP-LP-80
DRIVE TYPE	DIRECT
WEIGHT - LBS	14
CAPACITY - CFM	80
STATIC PRESSURE IN. WG	0.25
FAN RPM	871
MOTOR WATTS	18.5
MOTOR VOLTAGE/PHASE	120/1
CONTROL	LOCAL LIGHT
INTERLOCK WITH:	-
OPTIONS TO BE PROVIDED:	A,B,C,D,E,F
AVAILABLE OPTIONS	
A: UL 507 LISTED. B: SOLID STATE SPEED CONTROL; MOUNTED AND WIRED INTERNALLY.	
C: RECTANGULAR HOODED WALL CAP. D: GRILLE FILTER. E: ROUND DUCT CONNECTION.	
F: VIBRATION ISOLATION KIT.	

**FLOOR PLAN**  
SCALE: 1/8"=1'-0"

**CLAGGETT ENGINEERING**

Professional Certification. I hereby certify that these documents were prepared or approved by me, and that I am a duly licensed professional engineer under the laws of the State of Maryland, License Number 14034, Expiration Date 7-24-24.

122 NORTH HARRISON STREET  
EASTON, MARYLAND 21601  
TEL (410) 820-9173

---

**St. Vincent de Paul Addition**  
Talbot County, MD

SCALE	AS NOTED	REVISIONS	BY	DATE
DATE	4-24-24			
DRN	CE	CHK	LGC	
AP'VD	LGC			
TITLE	HVAC PLAN			NO. M101



**SPECIAL NOTES** (APPLY TO THIS DRAWING ONLY)

- 1 RELOCATE EX CW, GAS, REFRIG. LINE SETS AND ELECTRICAL CONDUIT TO 9'-0" AFF TO CLEAR NEW 8'-0" DOOR.
- 2 RELOCATE EX SINK. REMOVE EX WATER AND VENT BACK TO ACTIVE MAIN AND CAP. REMOVE SAN TO BELOW FINISHED FLOOR AND CAP.
- 3 PROVIDE 1/2" CW, HW, 2" V AND 2" SAN TO RELOCATED SINK OR NEW LAVATORY.
- 4 REMOVE EX HOSE BIBB. PROVIDE NEW HOSE BIBB HB AS INDICATED.
- 5 PROVIDE CONDENSATE PUMP TO RECEIVE CONDENSATE FROM HP AND PUMP IT OVER CEILING TO SPILL ON GRADE. EQUAL OF LITTLE GIANT VCMA-20UL, 1/30 HP, 115V, 1 PH, 60 #, 1.5 AMPS, 93 WATTS, 48 GPH @ 10 FT HD, 6 FT CORD.
- 6 INSTALL 1-1/4" G FROM NEW FURNACE ALL THE WAY BACK METER LOCATION.
- 7 CONNECT TO EXISTING SANITARY PIPING BELOW GRADE IN THIS AREA. CUT EXISTING SLAB AND TRENCH AS REQUIRED TO INSTALL NEW SANITARY PIPING. CONFIRM SIZE AND EXACT LOCATION OF PIPING PRIOR TO STARTING WORK. REPORT ANY IRREGULARITIES. AFTER INSTALLATION BACK FILL AND COMPACT WITH CLEAN GRAVEL TO INITIAL SUB GRADE. REPAIR TO MATCH EXISTING.
- 8 AC-1 OUTDOOR UNIT TO BE INSTALLED ON 4" HOUSEKEEPING PAD.
- 9 1/2" HW. CONNECT TO EXISTING AT 3-WAY MIXING VALVE.

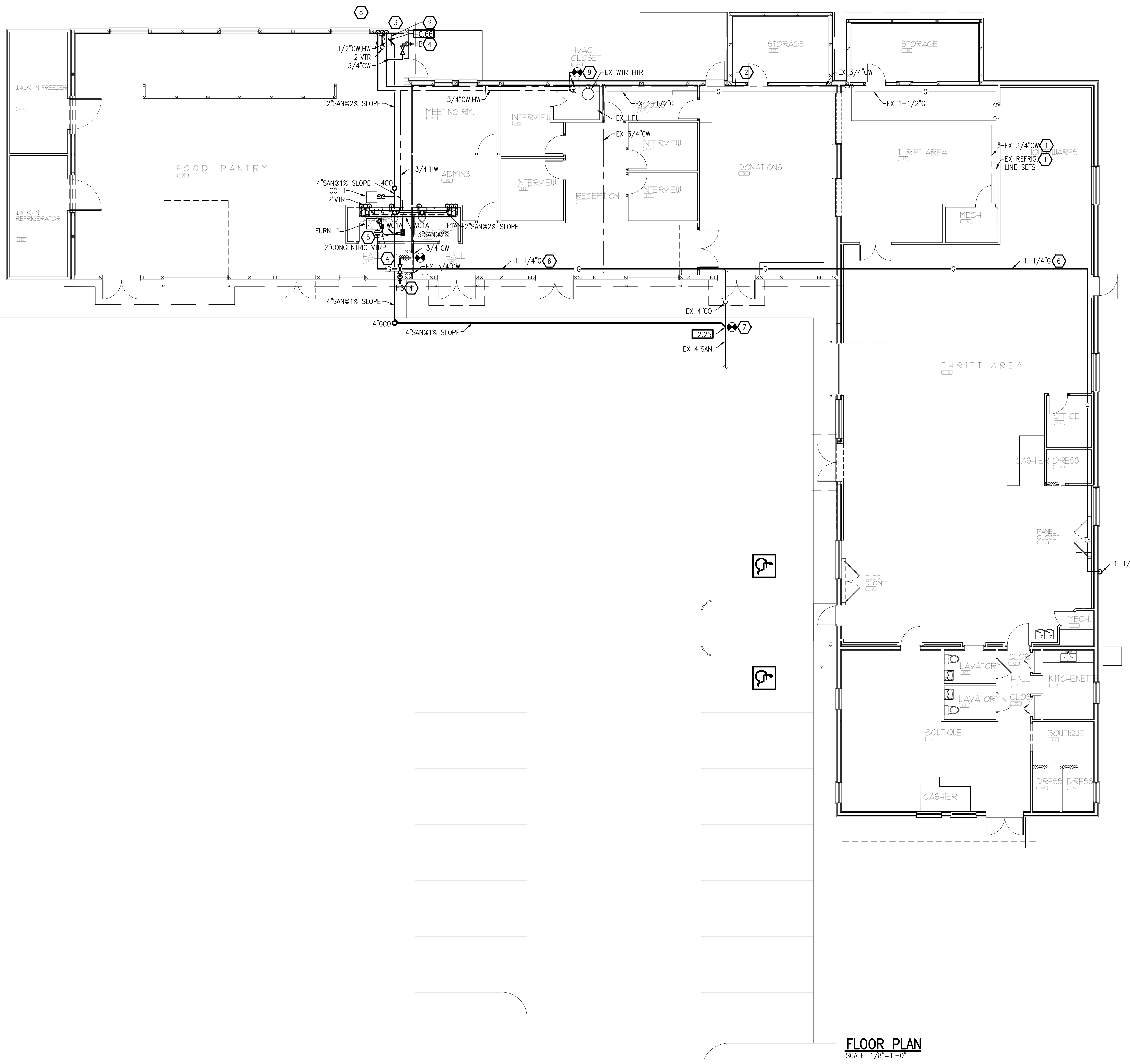

PLUMBING FIXTURE SCHEDULE								
MARK	FIXTURE DESCRIPTION	MOUNTING HEIGHT	--- MIN CONNECTIONS ---			MANUFACTURER	FIXTURE	TRIM/ACCESSORIES/CONTROLS
			CW	HW	WASTE			
WC1A	WATER CLOSET ADA COMPLIANT 1.28 GPF, FLOOR MOUNTED, ELONGATED, TANK, SIPHON ACTION FLUSH, ADA COMPLIANT.	17" AFF	1/2	-	3	AMERICAN STANDARD	CADET PRO 215AA.104	CHURCH: 9500CT ELONGATED OPEN FRONT SEAT.
L1A	LAVATORY HANDICAPPED ACCESSIBLE	FLOOR TO TOP OF RIM 34"	1/2	1/2	1-1/4	AMERICAN STANDARD	LUCERNE 0355.012	AS: 5500.145 CENTERSET LAVATORY MONTERREY 0.5 GPM TWO LEVER HANDLE LAVATORY FAUCET. PROVIDE CONCEALED ARM SUPPORT. WALL HUNG, 4" CENTERSET, 0.5 GPM, TWO LEVER HANDLE FAUCET, OFFSET GRID STRAINER DRAIN AND INSULATED PIPING, HANDLE RESISTANT.
HB	HOSE BIBB, VACUUM BREAKER	24" AFF	3/4	-	-	WATTS	HY-420	NON-FREEZE HOSE BIBB WITH CHROME FACE AND INTEGRAL VACUUM BREAKER.
CO	CLEANOUT	-	-	-	-	AS NOTED	ZURN	ZN-1400 HEAVY-DUTY "LEVEL-TROL" ADJUSTABLE FLOOR CLEAN OUT
GCO	FLOOR CLEANOUT HEAVY DUTY	-	-	-	-	AS NOTED	ZURN	ZN-1400-HD EXTRA HEAVY-DUTY "LEVEL-TROL" ADJUSTABLE CLEAN OUT

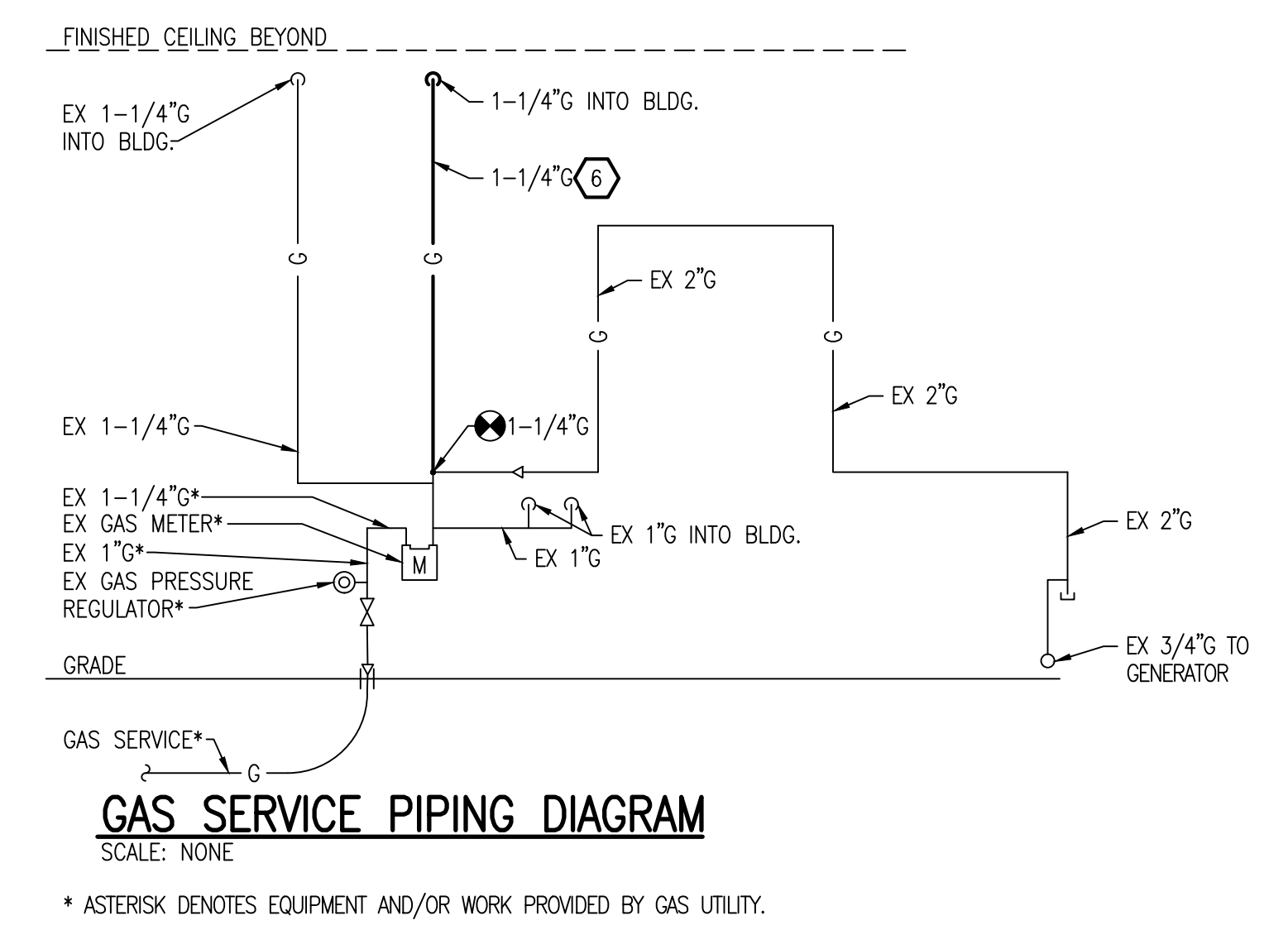

**FLOOR PLAN**  
SCALE: 1/8"=1'-0"

**CLAGGETT ENGINEERING**

Professional Certification. I hereby certify that these documents were prepared or approved by me, and that I am a duly licensed professional engineer under the laws of the State of Maryland. License Number 14034, Expiration Date 7-24-24.

122 NORTH HARRISON STREET  
EASTON, MARYLAND 21601  
TEL (410) 820-9173

St. Vincent de Paul Addition Talbot County, MD		NO.	M201
SCALE AS NOTED	REVISIONS	BY	DATE
DATE 4-24-24			
DRN CE	CKD LGC		
APVD LGC			
TITLE	PLUMBING PLAN		

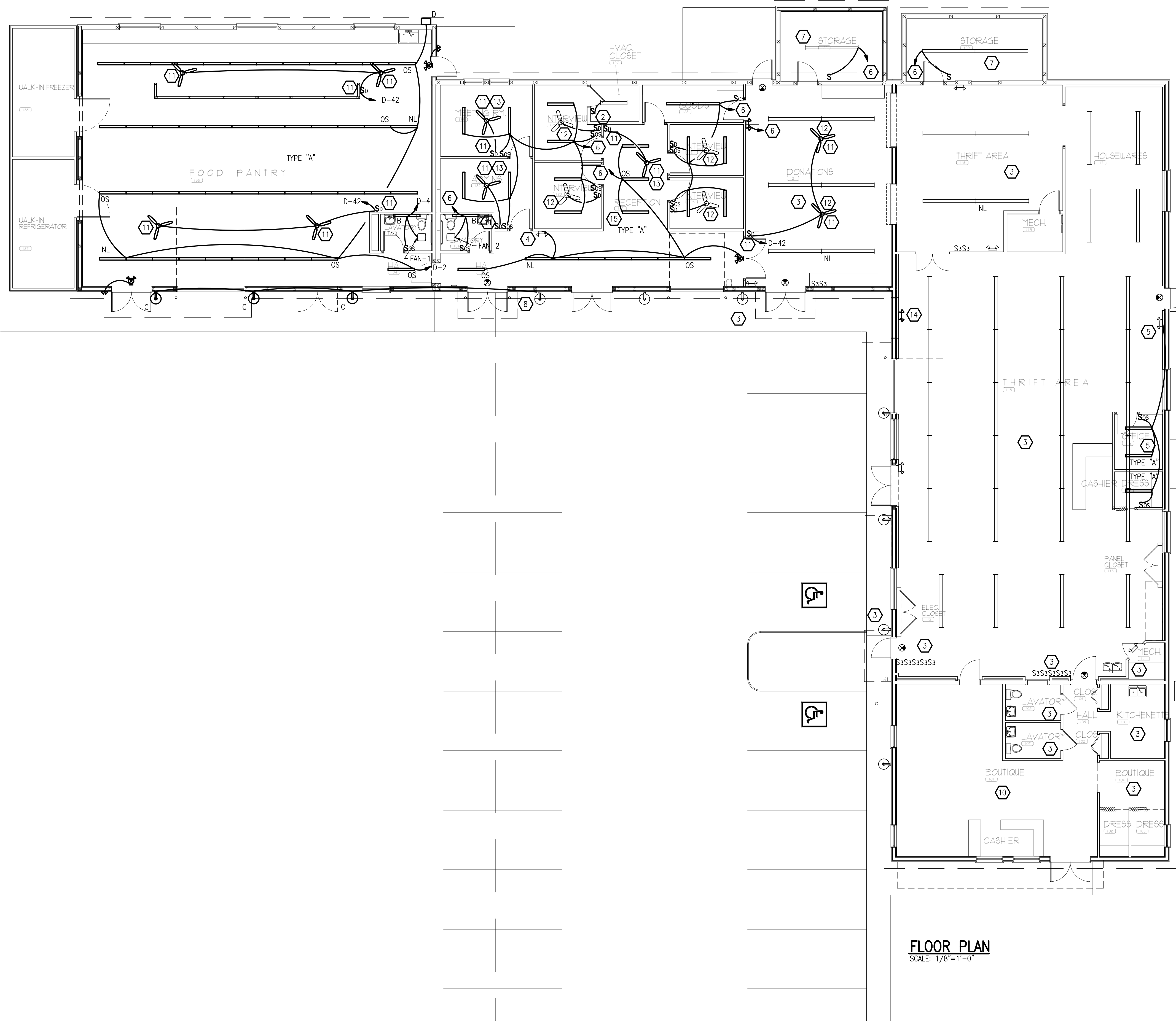

**FLOOR PLAN**  
SCALE: 1/8"=1'-0"

**SPECIAL NOTES** (APPLY TO THIS DRAWING ONLY)

- 1 UNLESS INDICATED OTHERWISE, REMOVE LIGHT FIXTURES AND ASSOCIATED WIRING AND CONTROLS BACK TO ACTIVE CIRCUITRY AND MAKE SAFE. PRESERVE FIXTURES FOR REINSTALLATION.
- 2 REMOVE AND REINSTALL SWITCH TO ALLOW CONSTRUCTION OF NEW DOOR. CONNECT TO EXISTING LIGHT FIXTURE
- 3 UNLESS INDICATED OTHERWISE, EXISTING LIGHT FIXTURES, CONTROLS, AND CIRCUITING IN THIS AREA TO REMAIN.
- 4 REMOVE EXISTING EMERGENCY LIGHT AND REINSTALL WHERE INDICATED. CONNECT TO EXISTING LOCAL LIGHTING CIRCUIT AHEAD OF CONTROLS.
- 5 CONNECT NEW FIXTURES IN OFFICE 116 TO EXISTING LOCAL BRANCH LIGHTING CIRCUIT.
- 6 CONNECT TO EXISTING LOCAL LIGHTING BRANCH CIRCUIT.
- 7 REINSTALL FIXTURE SALVAGED FROM DEMOLITION.
- 8 CONNECT NEW BARN STYLE LIGHTS TO EXISTING BARN STYLE LIGHTS.
- 9 CONNECT TO EXISTING LIGHT FIXTURE AND CONTROLS.
- 10 REMOVE EXISTING FIXTURES IN THIS AREA AND REINSTALL IN NEW CEILING GRID IN APPROXIMATELY SAME LOCATION.
- 11 48" CEILING FAN EQUAL TO CANARM CP48DW1-N; 7370 CFM; WITH 16" DOWN ROD AND RREM-DC0014-W SPEED CONTROLLER. PROVIDE TWO #12 AND #12 GROUND WIRING TO FANS.
- 12 REMOVE EXISTING CEILING FAN AND ASSOCIATED WIRING AND CONTROLS. CLEAN FAN AND REINSTALL WHERE INDICATED. PROVIDE SPEED CONTROL SWITCH AND #12 WIRING. CONNECT TO CEILING FAN BREAKER IN PANEL C.
- 13 CONNECT TO CEILING FAN BREAKER IN PANEL C.
- 14 REMOVE EXISTING EXIT SIGN. PROVIDE EMERGENCY LIGHT AND CONNECT TO EXISTING WIRING.
- 15 SUPPORT THE THREE TYPE "A" FIXTURES IN RECEPTION 126 9'-0" AFF.

**LIGHTING FIXTURE SCHEDULE**

TYPE	SYMBOL	DESCRIPTION	LAMPS	MOUNTING	MANUFACTURER	CONTROLS
A	—	4 FOOT GENERAL PURPOSE LENSED STRIP LED, STEEL HOUSING AND ENDS, FROSTED ACRYLIC LENS, CONTINUOUS RUN, OCCUPANCY SENSOR, 4000K. PROVIDE SURFACE MOUNTING CLIPS, SEAMLESS CONNECTOR, AND LINKING CABLES AS REQUIRED. NL DENOTES NIGHT LIGHT. OS DENOTES OCCUPANCY SENSOR.	2000 LU, 15W	SURFACE CEILING	LIGHT EFFICIENT DESIGN: RPL01-G1-4F-SSCNDMM--OC2	
B	—	4 FOOT LENSED STRIP LED, STEEL HOUSING AND ENDS, FROSTED ACRYLIC LENS, EMERGENCY BATTERY PACK, 3500K.	2575 LU, 19W	SURFACE WALL 7'-2" AFF	COLUMBIA: LCL435-LW-EUELL14	
C	⊙	BARN STYLE LIGHT, BY OWNER		SURFACE WALL SEE ARCHITECT ELEVATIONS		
D	□	LED WALL PACK, FULL CUT-OFF IDA COMPLIANT, DIE CAST ALUMINUM HOUSING AND DOOR, TEMPERED GLASS LENS, TYPE 3 WIDE THROW DISTRIBUTION, UL WET LOCATION LISTED, BUTTON PHOTOCELL CONTROL.	2610 LU, 29W	WALL 10' AFF	HUBBELL: LNC2-12L-4K-3-U-PCU	
E	⬆	BATTERY POWERED LED EMERGENCY LIGHT WITH REMOTE CAPABILITY AND REMOTE EMERGENCY LED HEADS WHERE INDICATED. WHITE THERMOPLASTIC HOUSING, FULLY ADJUSTABLE HEADS, SELF-TESTING.	3W LED LAMPS	WALL 7'-6" AFF	COMPASS: CUZ SERIES	CONNECT TO LOCAL LIGHTING CIRCUIT AHEAD OF ANY CONTROLS
X	⬆	BATTERY POWERED ILLUMINATED LED EXIT SIGN, COMBINATION LED EMERGENCY LIGHT/EXIT SIGN AND REMOTE EMERGENCY LED FIXTURES. UNIVERSAL MOUNTING, THERMOPLASTIC HOUSING, REMOTE CAPABILITY, SELF-TESTING.	3W LED LAMPS	SURFACE CEILING WALL 7'-6" AFF	DUALITE: EVC SERIES	CONNECT TO LOCAL LIGHTING CIRCUIT AHEAD OF ANY CONTROLS
		MATCHING OUTDOOR REMOTE HEADS,	3W LED	WALL 7'-6" AFF	DUALITE: EVO SERIES	

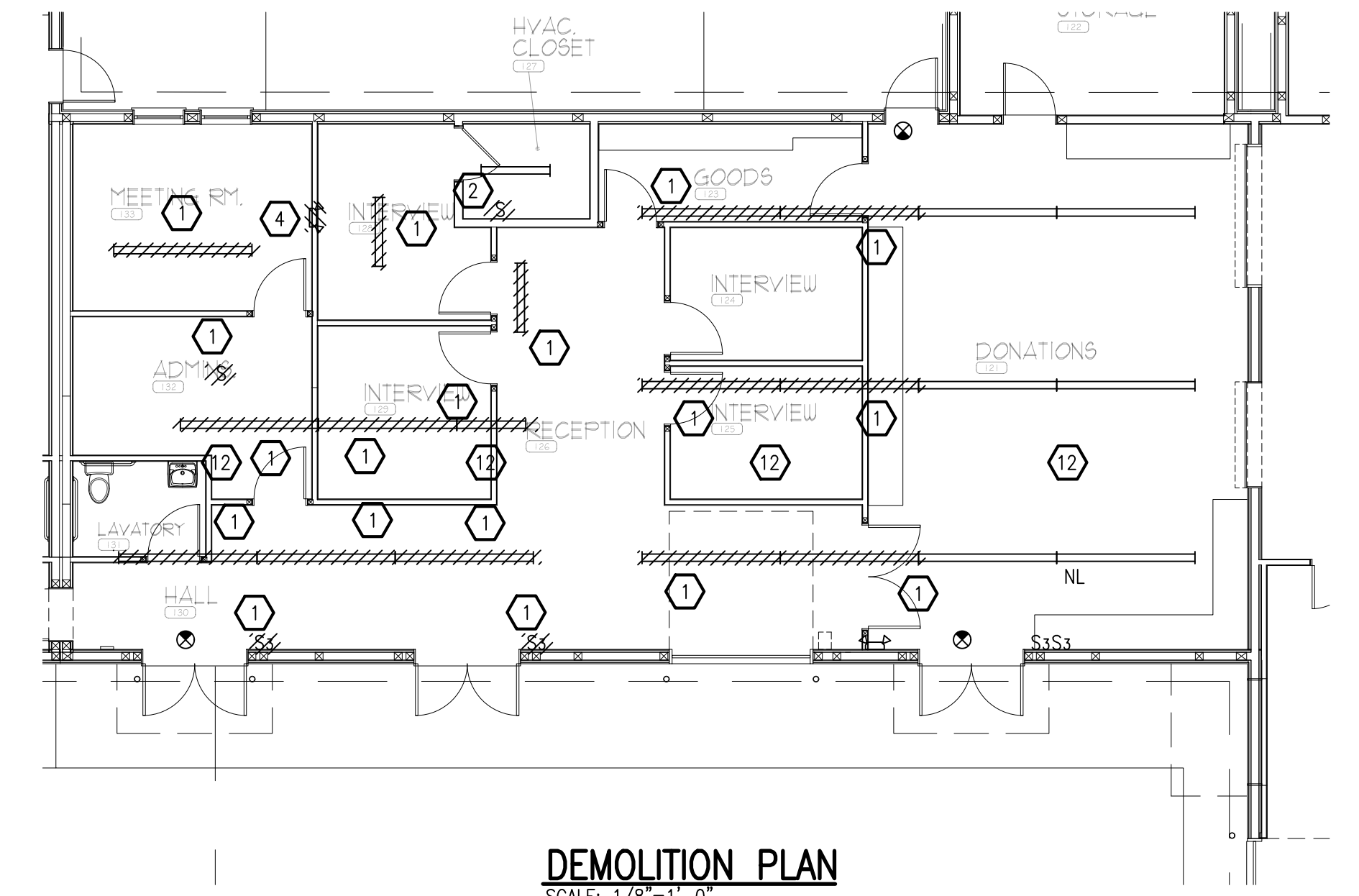

**DEMOLITION PLAN**  
SCALE: 1/8"=1'-0"

**CLAGGETT ENGINEERING**  
122 NORTH HARRISON STREET  
EASTON, MARYLAND 21601  
TEL (410) 820-9173

Professional Certification. I hereby certify that these documents were prepared or approved by me, and that I am a duly licensed professional engineer under the laws of the State of Maryland, License Number 14034, Expiration Date 7-24-24.

St. Vincent de Paul Addition  
Talbot County, MD

SCALE	AS NOTED	REVISIONS	BY	DATE
DATE	4-24-24			
DRN	CE	CKD	LGC	
APVD	LGC			
TITLE	LIGHTING PLAN		NO. E101	



**SPECIAL NOTES** (APPLY TO THIS DRAWING ONLY)

- 1 NOT USED.
- 2 PROVIDE DEDICATED RECEPTACLE AND CIRCUIT FOR FORK LIFT BATTERY CHARGING STATION. COORDINATE WITH EXISTING FORK LIFT REQUIREMENTS.
- 3 RESTROOM EXHAUST FAN TO BE CONTROLLED WITH LIGHTS.
- 4 JUNCTION BOX ON TOP OF WALK-IN BOX FOR CONNECTION TO WALK-IN BOX LIGHTS AND DIGITAL THERMOMETER.
- 5 JUNCTION BOX ON TOP OF WALK-IN BOX FOR CONNECTION TO WALK-IN BOX DOOR AND RELIEF VENT HEAT.
- 6 60A, 240V, 1 PHASE, NEMA 3R DISCONNECT.
- 7 30A, 240V, 3 PHASE, NEMA 3R DISCONNECT.
- 8 30A, 240V, 1 PHASE, MANUAL MOTOR STARTER DISCONNECT. INSTALL LEVEL WITH UNIT SERVED.
- 9 REMOVE EXISTING RECEPTACLE AND ASSOCIATED WIRING BACK TO ACTIVE CIRCUITRY AND MAKE SAFE. PROVIDE #12 WIRING AS REQUIRED TO PRESERVE EXISTING CIRCUIT CONTINUITY.
- 10 REMOVE EXISTING WIRING AND CONDUIT ASSOCIATED WITH WALK-IN BOX BACK TO EXISTING PANEL "C".
- 11 30 AMP, 240V, 1 PHASE, NEMA 1 DISCONNECT FOR OVERHEAD DOOR. CONNECT TO DOOR OPERATOR. PROVIDE ALL OVERHEAD DOOR CONTROL WIRING IN 1/2" CONDUIT. CONTROLS MAY INCLUDE CONTROL TRANSFORMER, PUSH BUTTON CONTROL PANEL, OVER-RIDE SAFETY CONTROLS, SIDE LATCH SAFETY SWITCH, WARNING LIGHTS AND HORN.
- 12 REMOVE EXISTING 3 PHASE PANEL AT THIS LOCATION AND PRESERVE FOR REINSTALLATION. PRESERVE EXISTING BRANCH CIRCUITS FOR CONNECTION TO NEW PANEL. PROVIDE NEW PANEL C AS SCHEDULED AND RECONNECT EXISTING BRANCH CIRCUITS TO NEW PANEL.
- 13 INSTALL EXISTING 3 PHASE PANEL AT THIS LOCATION.
- 14 PROVIDE NEW RECEPTACLES AND CONNECT TO EXISTING LOCAL RECEPTACLE BRANCH CIRCUIT.

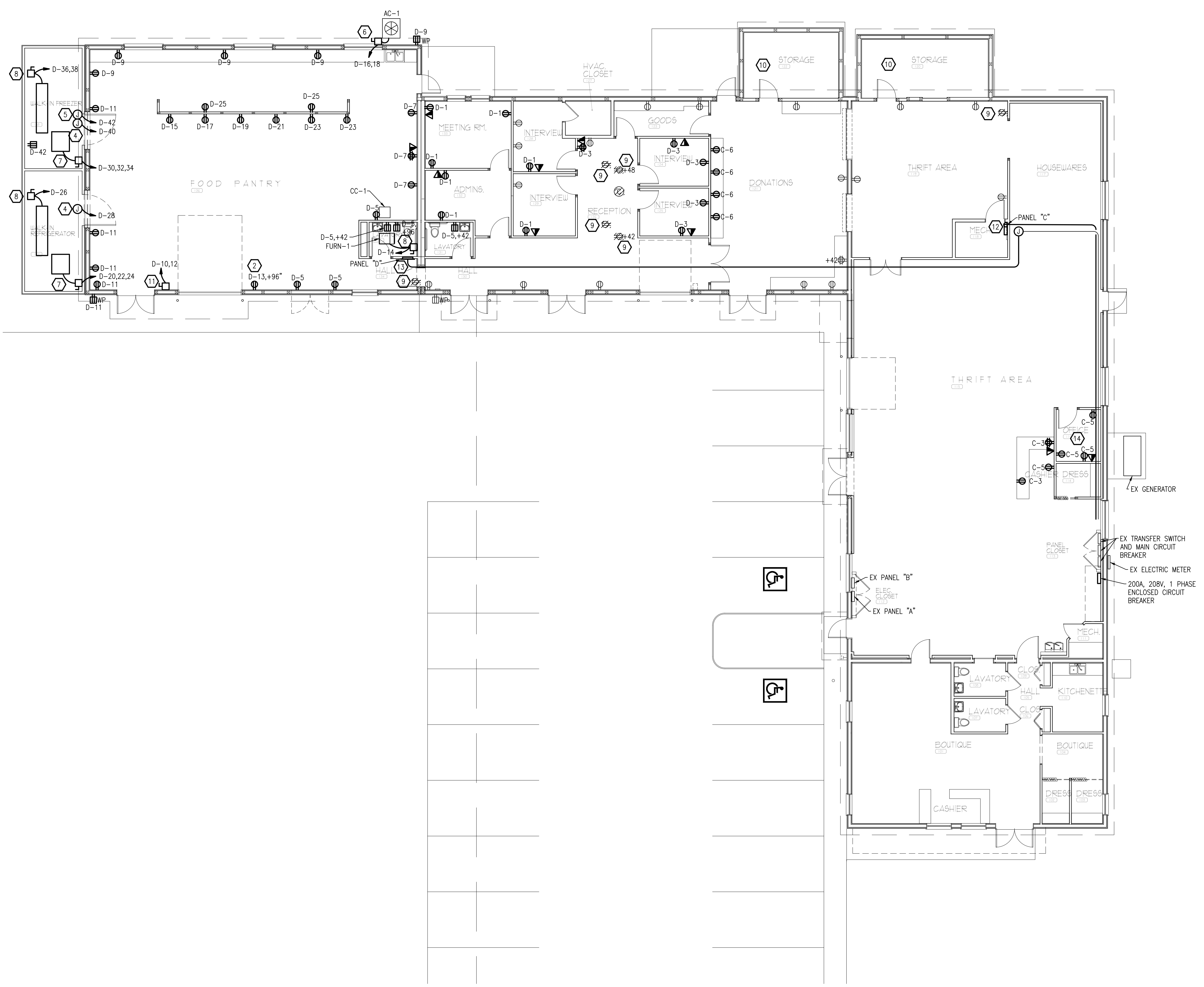

**FLOOR PLAN**  
SCALE: 1/8"=1'-0"

	<b>CLAGGETT ENGINEERING</b>		122 NORTH HARRISON STREET EASTON, MARYLAND 21601 TEL (410) 820-9173
	<small>Professional Certification. I hereby certify that these documents were prepared or approved by me, and that I am a duly licensed professional engineer under the laws of the State of Maryland. License Number 14034, Expiration Date 7-24-24.</small>		
<b>St. Vincent de Paul Addition</b> <b>Talbot County, MD</b>			
SCALE AS NOTED	REVISIONS	BY	DATE
DATE 4-24-24			
DRN CE CKD LGC			
APVD LGC			
TITLE	POWER PLAN		NO. E201



FLUSH MOUNTED 120/208V, 1PH, 3W.										EX PANEL "A" SIEMENS G4040B1200										MAIN BKR 200 MAIN LUGS -					
POLE NO.	TRIP AMP	BKR POLE	WIRE	GND WIRE	COND	SERVES	LOAD K.V.A.	POLE NO.	TRIP AMP	BKR POLE	WIRE	GND WIRE	COND	SERVES	LOAD K.V.A.	POLE NO.	TRIP AMP	BKR POLE	WIRE	GND WIRE	COND	SERVES			
1	20	1	-	-	-	LIGHTS-EXISTING	-	2	20	1	-	-	-	RECEPTACLE-EXISTING	-	4	20	1	-	-	-	RECEPTACLE-EXISTING	-		
3	40	2	-	-	-	COOKTOP-EXISTING	-	6	20	1	-	-	-	RECEPTACLE-EXISTING	-	8	20	1	-	-	-	RECEPTACLE-EXISTING	-		
5	30	2	-	-	-	MICROWAVE-EXISTING	-	10	20	1	-	-	-	RECEPTACLE-EXISTING	-	12	20	1	-	-	-	RECEPTACLE-EXISTING	-		
7	20	1	-	-	-	ICE MAKER-EXISTING	-	14	20	1	-	-	-	RECEPTACLE-EXISTING	-	16	20	1	-	-	-	RECEPTACLE-EXISTING	-		
9	20	2	-	-	-	WALL OWEN-EXISTING	-	18	20	1	-	-	-	RECEPTACLE-EXISTING	-	20	20	1	-	-	-	RECEPTACLE-EXISTING	-		
11	-	-	-	-	-	SPACE	-	22	20	1	-	-	-	RECEPTACLE-EXISTING	-	24	20	1	-	-	-	RECEPTACLE-EXISTING	-		
13	-	-	-	-	-	SPACE	-	26	20	1	-	-	-	RECEPTACLE-EXISTING	-	28	20	1	-	-	-	RECEPTACLE-EXISTING	-		
15	-	-	-	-	-	SPACE	-	30	20	1	-	-	-	RECEPTACLE-EXISTING	-	32	20	1	-	-	-	RECEPTACLE-EXISTING	-		
17	-	-	-	-	-	DISPOSAL-EXISTING	-	34	50	2	-	-	-	AC-EXISTING	-	36	20	1	-	-	-	RECEPTACLE-EXISTING	-		
19	-	-	-	-	-	DISHWASHER-EXISTING	-	38	20	1	-	-	-	GAS FURNACE-EXISTING	-	40	20	1	-	-	-	RECEPTACLE-EXISTING	-		
21	-	-	-	-	-	FIRE ALARM-EXISTING	-	42	20	1	-	-	-	GAS FURNACE-EXISTING	-	-	-	-	-	-	-	-	-	-	
23	30	1	-	-	-	REFRIGERATOR-EXISTING	-	-	-	-	-	-	-	-	-	-	-	-	-	-	-	-	-	-	
25	20	1	-	-	-	LOW FREEZER-EXISTING	-	-	-	-	-	-	-	-	-	-	-	-	-	-	-	-	-	-	
27	20	1	-	-	-	TRACK LIGHT-EXISTING	-	-	-	-	-	-	-	-	-	-	-	-	-	-	-	-	-	-	
29	20	1	-	-	-	TRACK LIGHT-EXISTING	-	-	-	-	-	-	-	-	-	-	-	-	-	-	-	-	-	-	
31	20	1	-	-	-	TRACK LIGHT-EXISTING	-	-	-	-	-	-	-	-	-	-	-	-	-	-	-	-	-	-	
33	20	1	-	-	-	TRACK LIGHT-EXISTING	-	-	-	-	-	-	-	-	-	-	-	-	-	-	-	-	-	-	
35	20	1	-	-	-	TRACK LIGHT-EXISTING	-	-	-	-	-	-	-	-	-	-	-	-	-	-	-	-	-	-	
37	20	1	-	-	-	TRACK LIGHT-EXISTING	-	-	-	-	-	-	-	-	-	-	-	-	-	-	-	-	-	-	
39	20	1	-	-	-	TRACK LIGHT-EXISTING	-	-	-	-	-	-	-	-	-	-	-	-	-	-	-	-	-	-	
41	-	-	-	-	-	-	-	-	-	-	-	-	-	-	-	-	-	-	-	-	-	-	-	-	-
CONNECTED K.V.A. PER PHASE							-	- KVA x 1.25 GROWTH = - KVA/0.240KV = - AMPS																	

FLUSH MOUNTED 120/208V, 1PH, 3W.										EX PANEL "B" SIEMENS G4040B1200										MAIN BKR 200 MAIN LUGS -					
POLE NO.	TRIP AMP	BKR POLE	WIRE	GND WIRE	COND	SERVES	LOAD K.V.A.	POLE NO.	TRIP AMP	BKR POLE	WIRE	GND WIRE	COND	SERVES	LOAD K.V.A.	POLE NO.	TRIP AMP	BKR POLE	WIRE	GND WIRE	COND	SERVES			
1	20	1	-	-	-	EXISTING	-	2	20	1	-	-	-	COMPUTER SERVER-EXISTING	-	4	20	1	-	-	-	EXISTING	-		
3	20	1	-	-	-	EXISTING	-	6	20	1	-	-	-	FLOODLIGHT VIA TIME CLOCK-EXISTING	-	8	20	1	-	-	-	EXISTING	-		
5	20	1	-	-	-	EXISTING	-	10	20	1	-	-	-	EXISTING	-	12	20	1	-	-	-	EXISTING	-		
7	20	1	-	-	-	EXISTING	-	14	20	1	-	-	-	EXISTING	-	16	20	1	-	-	-	EXISTING	-		
9	20	1	-	-	-	EXISTING	-	18	20	1	-	-	-	EXISTING	-	20	20	1	-	-	-	EXISTING	-		
11	20	1	-	-	-	EXISTING	-	22	30	2	-	-	-	EXISTING	-	24	30	2	-	-	-	EXISTING	-		
13	20	1	-	-	-	EXISTING	-	26	-	-	-	-	-	SPACE	-	28	-	-	-	-	-	SPACE	-		
15	20	1	-	-	-	EXISTING	-	30	60	2	-	-	-	AC-EXISTING	-	32	20	1	-	-	-	EXISTING	-		
17	20	1	-	-	-	EXISTING	-	34	20	1	-	-	-	FLOODLIGHT-EXISTING	-	36	20	1	-	-	-	ALARM, TEL. BD.-EXISTING	-		
19	20	1	-	-	-	EXISTING	-	38	20	2	-	-	-	TIME CLOCK-EXISTING	-	40	20	2	-	-	-	EXISTING	-		
21	20	1	-	-	-	EXISTING	-	42	-	-	-	-	-	-	-	-	-	-	-	-	-	-	-	-	
23	20	1	-	-	-	EXISTING	-	-	-	-	-	-	-	-	-	-	-	-	-	-	-	-	-	-	
25	20	1	-	-	-	EXISTING	-	-	-	-	-	-	-	-	-	-	-	-	-	-	-	-	-	-	
27	20	1	-	-	-	EXISTING	-	-	-	-	-	-	-	-	-	-	-	-	-	-	-	-	-	-	
29	20	1	-	-	-	EXISTING	-	-	-	-	-	-	-	-	-	-	-	-	-	-	-	-	-	-	
31	20	1	-	-	-	EXISTING	-	-	-	-	-	-	-	-	-	-	-	-	-	-	-	-	-	-	
33	20	1	-	-	-	EXISTING	-	-	-	-	-	-	-	-	-	-	-	-	-	-	-	-	-	-	
35	20	1	-	-	-	EXISTING	-	-	-	-	-	-	-	-	-	-	-	-	-	-	-	-	-	-	
37	20	1	-	-	-	EXISTING	-	-	-	-	-	-	-	-	-	-	-	-	-	-	-	-	-	-	
39	30	2	-	-	-	AC-EXISTING	-	-	-	-	-	-	-	-	-	-	-	-	-	-	-	-	-	-	
41	-	-	-	-	-	-	-	-	-	-	-	-	-	-	-	-	-	-	-	-	-	-	-	-	-
CONNECTED K.V.A. PER PHASE							-	- KVA x 1.25 GROWTH = - KVA/0.240KV = - AMPS																	

SURFACE MOUNTED 120/208V, 1PH, 3W.										PANEL "C" SQUARE D QO140L200G										MAIN BKR - MAIN LUGS 200				
POLE NO.	TRIP AMP	BKR POLE	WIRE	GND WIRE	COND	SERVES	LOAD K.V.A.	POLE NO.	TRIP AMP	BKR POLE	WIRE	GND WIRE	COND	SERVES	LOAD K.V.A.	POLE NO.	TRIP AMP	BKR POLE	WIRE	GND WIRE	COND	SERVES		
1	20	1	-	-	-	EXISTING	-	2	20	1	-	-	-	EXISTING	-	4	20	1	-	-	-	EXISTING	-	
3	20	1	2#12	1#12	3/4	RECEPTACLES - THRIFT AREA	-	6	20	1	2#12	1#12	3/4	RECEPT DONATIONS	-	8	20	1	-	-	-	EXISTING	-	
5	20	1	2#12	1#12	3/4	RECEPTACLES - THRIFT AREA OFFICE	-	10	20	1	-	-	-	EXISTING	-	12	20	1	-	-	-	EXISTING	-	
7	20	1	-	-	-	EXISTING	-	14	20	1	-	-	-	EXISTING	-	16	20	1	-	-	-	EXISTING	-	
9	20	1	-	-	-	EXISTING	-	18	20	1	-	-	-	EXISTING	-	20	20	1	-	-	-	EXISTING	-	
11	20	1	-	-	-	EXISTING	-	22	20	1	-	-	-	EXISTING	-	24	20	1	-	-	-	EXISTING	-	
13	20	1	-	-	-	EXISTING	-	26	20	1	-	-	-	EXISTING	-	28	20	1	-	-	-	EXISTING	-	
15	20	1	-	-	-	EXISTING	-	30	20	1	-	-	-	EXISTING	-	32	20	1	-	-	-	EXISTING	-	
17	20	1	-	-	-	EXISTING	-	34	20	1	-	-	-	EXISTING	-	36	20	1	-	-	-	FURNACE - EXISTING	-	
19	20	1	-	-	-	EXISTING	-	38	50	2	-	-	-	EXISTING	-	40	20	1	-	-	-	EXISTING	-	
21	20	1	-	-	-	EXISTING	-	-	-	-	-	-	-	-	-	-	-	-	-	-	-	-	-	-
23	30	2	-	-	-	EXISTING	-	-	-	-	-	-	-	-	-	-	-	-	-	-	-	-	-	-
25	20	1	2#12	1#12	3/4	RECEPTACLES - THRIFT AREA	-	-	-	-	-	-	-	-	-	-	-	-	-	-	-	-	-	-
27	20	1	-	-	-	EXISTING	-	-	-	-	-	-	-	-	-	-	-	-	-	-	-	-	-	-
29	20	1	-	-	-	EXISTING	-	-	-	-	-	-	-	-	-	-	-	-	-	-	-	-	-	-
31	20	1	-	-	-	EXISTING	-	-	-	-	-	-	-	-	-	-	-	-	-	-	-	-	-	-
33	20	1	-	-	-	EXISTING	-	-	-	-	-	-	-	-	-	-	-	-	-	-	-	-	-	-
35	-	-	-	-	-	SPACE	-	-	-	-	-	-	-	-	-	-	-	-	-	-	-	-	-	-
37	-	-	-	-	-	-	-	-	-	-	-	-	-	-	-	-	-	-	-	-	-	-	-	-
39	-	-	-	-	-	-	-	-	-	-	-	-	-	-	-	-	-	-	-	-	-	-	-	-
CONNECTED K.V.A. PER PHASE							-	- KVA x 1.25 GROWTH = - KVA/0.240KV = - AMPS																

FLUSH MOUNTED 120/208V, 3PH, 4W.										PANEL "D" SQUARE D QOC42										MAIN BKR - MAIN LUGS 200				
POLE NO.	TRIP AMP	BKR POLE	WIRE	GND WIRE	COND	SERVES	LOAD K.V.A.	POLE NO.	TRIP AMP	BKR POLE	WIRE	GND WIRE	COND	SERVES	LOAD K.V.A.	POLE NO.	TRIP AMP	BKR POLE	WIRE	GND WIRE	COND	SERVES		
1	20	1	2#12	1#12		RECEPT-ADMIN, MEETING	0.9	2	20	1	2#12	1#12		LIGHTS-FOOD PANTRY	0.8	4	20	1	2#12	1#12		TOILET ROOM LIGHT & FAN	0.8	
3	20	1	2#12	1#12		RECEPT-RECEPTION, INTER.	0.9	6	20	1	2#12	1#12		SPARE	0.8	8	20	1					SPARE	0.8
5	20	1	2#12	1#12		RECEPT-TOILETS, FOOD P.	0.8	10	20	1	2#12	1#12		SPARE	0.8	12	30	2	2#10	1#10			OVERHEAD DOOR	0.8
7	20	1	2#12	1#12		RECEPT-FOOD PANTRY	0.8	14	20	1	2#12	1#12		FURNACE	1.8	16	20	1	2#12	1#12			EXISTING	1.8
9	20	1	2#12	1#12		RECEPT-FOOD PANTRY	1.2	18	20	1	2#12	1#12		EXISTING	1.4	20	50	2	2#6	1#10	3/4		AC-1	1.4
11	20	1	2#12	1#12		RECEPT-FOOD PANTRY	1.4	22	20	1	2#12	1#12		EXISTING	1.4	24	20	3	4#12	1#12	3/4		WALK-IN REFRIG. COMP	1.4
13	20	1	2#12	1#12		RECEPT-FORK LIFT BATTERY	1.4	26	20	1	2#12	1#12		EXISTING	1.4	28	20	1	2#12	1#12			WALK-IN REFRIG. EVAP.	1.4
15	20	1	2#12	1#12		RECEPT-REACH IN	1.4	30	20	1	2#12	1#12		EXISTING	1.4	32	20	1	2#12	1#12			WALK-IN REFRIG. LIGHTS	1.4
17	20	1	2#12	1#12		RECEPT-REACH IN	1.4	34	20	1	2#12	1#12		EXISTING	1.4	36	20	2	2#12	1#12			WALK-IN FREEZER EVAP.	1.4
19	20	1	2#12	1#12		RECEPT-REACH IN	1.4	38	20	1	2#12	1#12		EXISTING	1.4	40								